

APPEARANCE

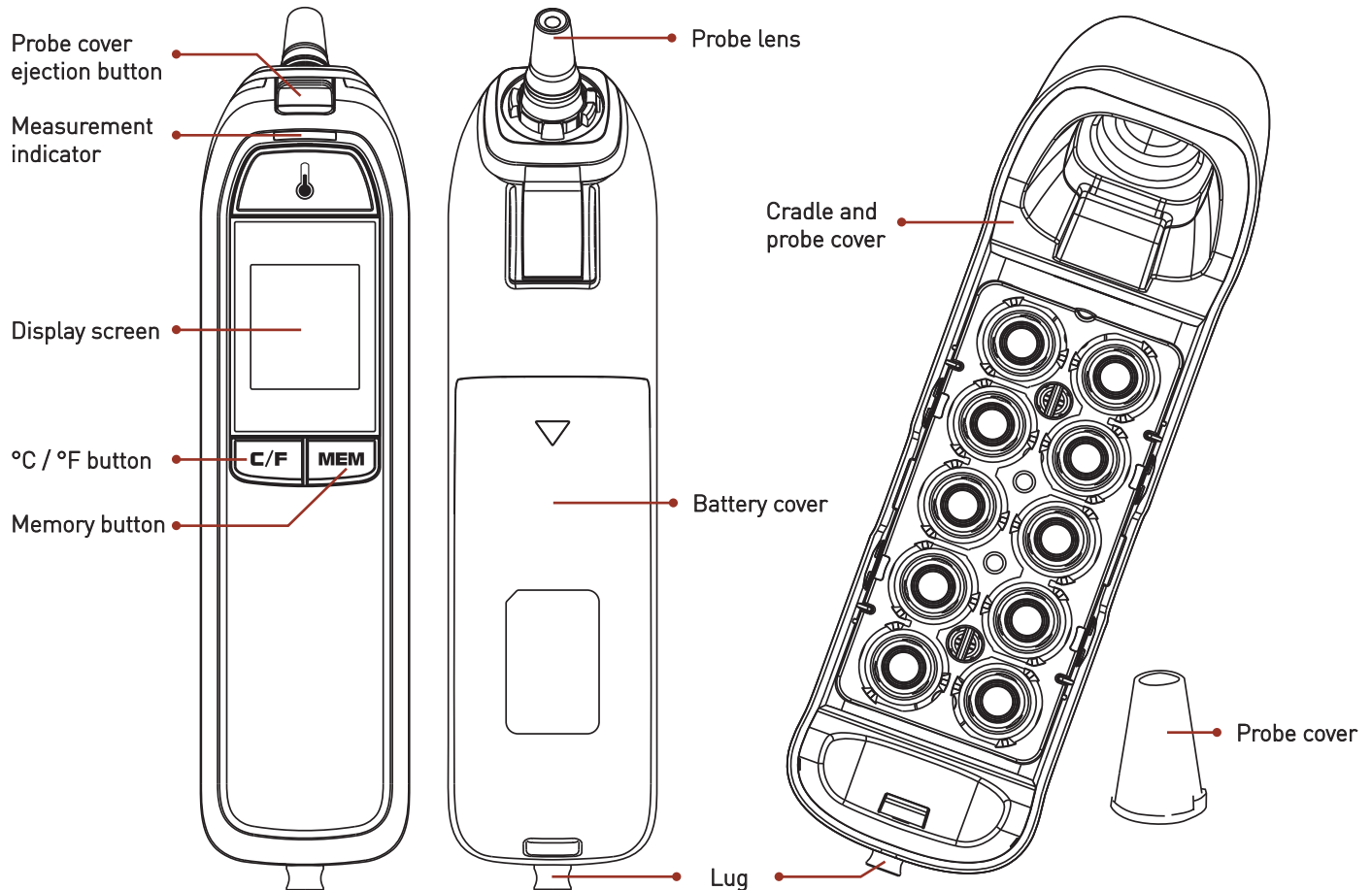

DISPLAY SCREEN

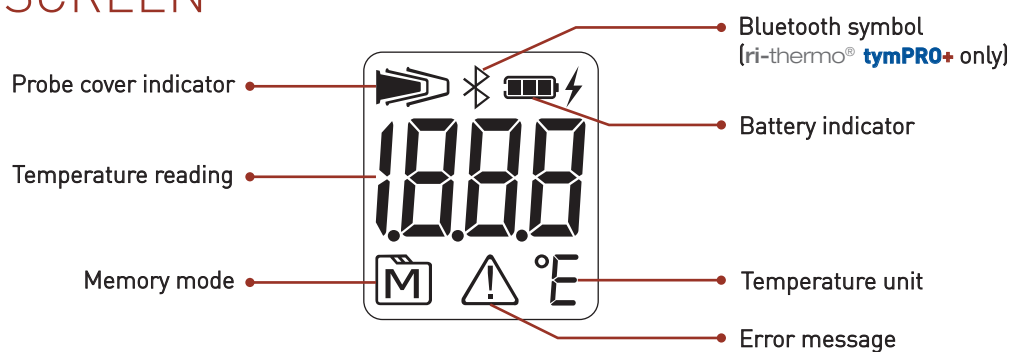



ORDERING INFORMATION

No. 1835-BT	Tympanic thermometer ri-thermo® tymPRO+ Bluetooth
No. 1835	Tympanic thermometer ri-thermo® tymPRO
No. 12634	Probe cover for ri-thermo® tymPRO 1 rack / 10 pcs
No. 12640	Probe cover for ri-thermo® tymPRO 30 racks / 300 pcs
No. 12911	Anti-theft cable, length 50 cm, black, keyring at both end for ri-thermo® tymPRO
No. 12953	Calibration kit for ri-thermo® tymPRO
No. 13347	Bluetooth connectivity: Bluetooth USB-Dongle for RVS-100

USING THE DEVICE

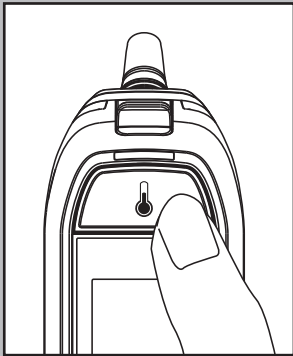
Measuring Temperature



STEP 1. To turn on ri-thermo® tymPRO, briefly press and release the  button. “”, when flashing, this indicates the tymPRO is ready to use and a new probe cover should be attached. Alternatively, attach a new probe cover to turn it on. When ready, the thermometer displays the last measurement.

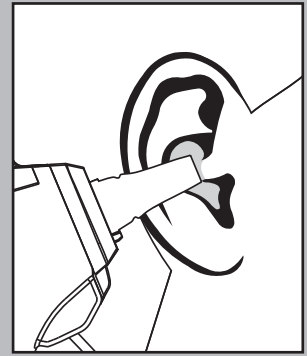
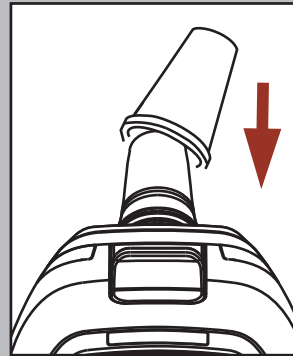
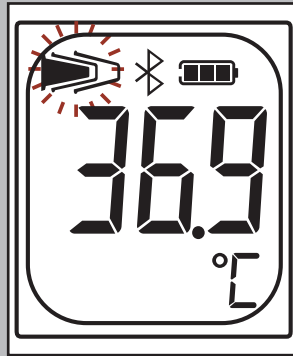

STEP 2. Gently fit the probe with a new probe cover into the ear canal. Ensure that the probe shaft is aligned with the ear canal.

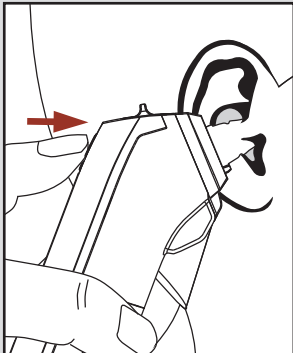

STEP 3. Briefly press and release the  button. You will hear a beep to indicate measurement is complete and thermometer may be removed. The indicator blinks during the measurement and turns solid blue when the measurement is completed.

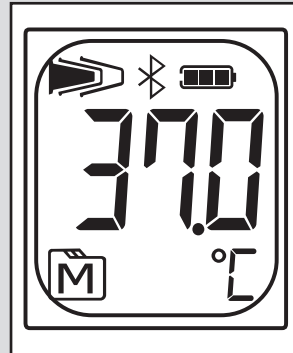
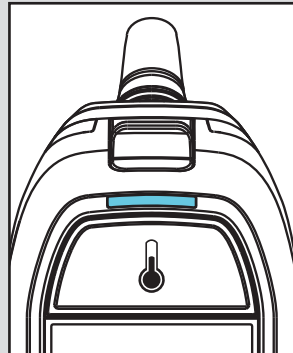

STEP 4. Read the result. The Bluetooth symbol is for ri-thermo® tymPRO+ only.

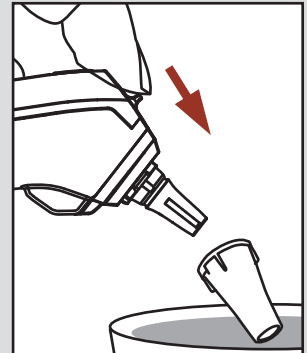

STEP 5. Press ejection button to discard used probe cover into clinical waste bin or recycling facilities (in line with local guidelines).

Replacing Probe Cover

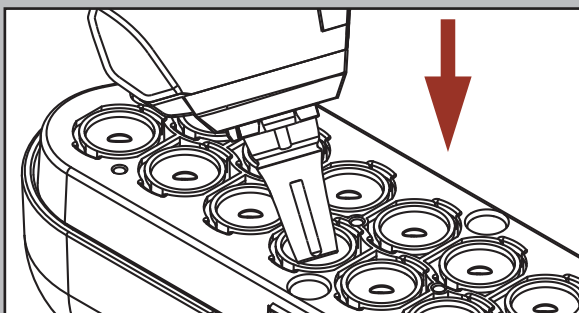

STEP 1. Firmly insert the thermometer probe into new probe cover in the probe cover cassette. You will hear two clicks when the probe cover is attached properly.

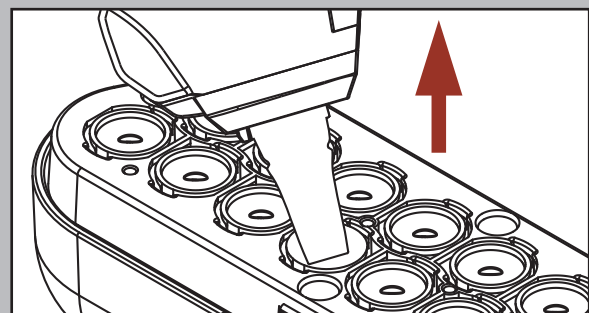

STEP 2. Lift the probe out of the cassette with a new probe cover attached. Do not touch the cover. Now, you can measure the temperature.

Please visit riester.de for more information



Refer to instructions for use for full functional usage

Rudolf Riester GmbH P.O. Box 35 | Bruckstraße 31 | 72417 Jungingen | Germany
Tel.: (+49) 7477-9270-0 | Fax.: (+49) 7477-9270-70 | info@riester.de | www.riester.de

 **Riester**